



GUARDIAN

— POOL HEATING —



ECOPRO SERIES

INVERTER POOL & SPA HEAT PUMP

INSTALLATION & OPERATION MANUAL

TABLE OF CONTENTS

- 1. FOREWARD..... 3
 - 1.1 WARNINGS..... 3
- 2. SPECIFICATIONS..... 4
 - 2.1 PERFORMANCE DATA..... 4
 - 2.2 DIMENSIONS..... 5
- 3. INSTALL & CONNECTION 6
 - 3.1 INSTALLATION DIAGRAM..... 6
 - 3.2 LOCATION OF INSTALLATION 6
 - 3.3 PLUMBING OF THE UNIT..... 6
 - 3.4 ELECTRICAL WIRING 7
 - 3.5 FIRST TIME STARTUP..... 7
- 4. USE & OPERATION 8
 - 4.1 THE CONTROL PANEL..... 8
 - 4.2 USING THE CONTROL PANEL 8
 - 4.2.1 ON/OFF MODE 8
 - 4.2.2 SWITCHING MODES..... 9
 - 4.2.3 SETTING THE TEMPERATURE..... 9
 - 4.2.4 CLOCK SETTINGS 10
 - 4.2.5 TIMER SETTINGS..... 10
 - 4.2.6 SILENT SETTINGS..... 11
 - 4.2.7 KEYBOARD LOCK..... 11
 - 4.2.8 FAULT INTERFACE..... 11
 - 4.3 TROUBLESHOOTING GUIDE 12
- 5. WI-FI OPERATION 14
 - 5.1 INTRODUCTION..... 14
 - 5.2 INSTALLATION 14
 - 5.3 APP SETUP..... 15
 - 5.3.1 CREATE AN ACCOUNT 15
 - 5.3.2 ADD YOUR DEVICE & CONFIGURE WI-FI..... 15
 - 5.3.3 DEVICE MANAGEMENT 17
- 6. MAINTENANCE & INSPECTION..... 19
- 7. APPENDIX..... 23
 - 7.1 CABLE SPECIFICATIONS..... 23
 - 7.2 REFRIGERANT SATURATION TEMPERATURE 23
 - 7.3 INTERFACE DIAGRAMS..... 23
 - 7.4 WIRING DIAGRAMS..... 25
 - 7.5 WARRANTY TERMS..... 28

BEFORE YOU BEGIN

- 1** Ensure that the heat pump arrives in good condition upon delivery.
- 2** Adequate airflow around the heat pump is vital, ensure that the surroundings are kept clear of debris, tree branches and anything that might impact the ventilation of the unit. Refer to Section 3.2 of this manual for more information.
- 3** Register your unit's warranty details and upload your invoice online at: www.guardianpoolheating.com.au/
- 4** Your unit should be installed in an outdoor area for maximum performance, for indoor installations contact Guardian for guidance.
- 5** Check the condensate drain of the heat pump regularly to avoid blockages or debris build up. Keeping it in good order ensures condensation easily drains from the unit.
- 6** When using Wi-Fi control, ensure that you have full Wi-Fi strength available where the heat pump is installed. You will require a 2.4GHz connection to use the Wi-Fi Controller App.

1. FOREWARD

Congratulations on purchasing your Guardian EcoPro high efficiency inverter pool heat pump!

Guardian heat pumps are designed and built to the highest industry standard and are backed by our extended warranty service for peace of mind.

A warranty registration is highly recommended to be submitted online at: www.guardianpoolheating.com.au

Ensure all information contained within this manual is read and fully understood before attempting to install or operate the pool heat pump.

If technical support or further information is required please contact support@guardianpoolheating.com.au

We trust you'll have a longer and more enjoyable time in your pool with your Guardian heat pump!

Thank you!

1.1 WARNINGS

Please read this manually carefully before installing or operating the unit.

The unit must only be installed by a qualified professional.

- The unit must be installed in accordance with national wiring regulations.
- Before obtaining access to terminals, all supply circuits must be disconnected.
- An all-pole disconnection device must be incorporated which as at least 3mm clearances in all poles, a leakage current that may exceed 10mA, residual current device (RCD) having a rated residual operating current not exceeding 30mA and disconnection must be incorporated in the fixed wiring in accordance with the wiring rules.
- Do not accelerate the defrosting process or clean the unit in any way that is not recommended in this manual.
- Do not store the unit in a room with continuously operating ignition sources, or install near any flammable gas.
- Do not pierce or burn the unit.
- Make sure the unit has good earthing and power connection to reduce the risk of electric shock.
- If the supply cord is damaged it must be replaced by the supplier to avoid hazards occurring.
- Ensure there is a circuit breaker for the unit to avoid electric shock or fires.
- Use supply wires suitable for 75°C
- The unit is equipped with an over-load protection system. It does not allow for the unit to start for at least 3 minutes from a previous stoppage.
- Be aware that refrigerants may not contain an odour.
- The installation of pipe-work should be kept to a minimum 30m²
- Caution: Single wall heat exchanger, not suitable for a potable water connection.
- Directive 2002/96/EC (WEEE):
The symbol depicting a crossed-out waste bin that is underneath the appliance indicates that this product, at the end of its useful life, must be handled separately from domestic waste, or must be taken to a recycling centre for electric and electronic devices.
- Directive 2002/95/EC (RoHs):
This product is compliant with directive 2002/95/EC (RoHs) concerning restrictions for the use of harmful substances in electric and electronic devices

Information in this manual is correct at the time of publishing and while the information is correct at the date of publication, changes in circumstances after the time of publication may impact on the accuracy of the information. The information may change without notice and Guardian is not in any way liable for the accuracy of any information printed and stored or in any way interpreted and used by a user.

2. SPECIFICATIONS

2.1 PERFORMANCE DATA

		GE-9	GE-12	GE-16	GE-20	GE-24	GE-28T	
Heating Capacity (27/24.3°C)	kW	2.3~9.0	2.5~12.0	3.1~16.0	3.70~20.0	6.5~24.3	7.1~28.2	
	Btu/h	7820~30600	8500~40800	10540~54400	12580~68000	22100~82620	24140~95880	
Heating Power Input	kW	0.16~1.41	0.18~1.90	0.22~2.54	0.27~3.22	0.45~3.74	0.49~4.41	
C.O.P		14.2~6.4	14.1~6.3	13.9~6.3	13.8~6.2	14.5~6.5	14.3~6.4	
Heating Capacity (15/12°C)	kW	1.7~7.0	2.1~9.0	2.4~12.6	2.6~14.5	4.5~19.0	5.1~21.0	
	Btu/h	5780~23800	7140~30600	8160~42840	8840~49300	15300~64600	17340~71400	
Heating Power Input	kW	0.24~1.46	0.29~1.91	0.34~2.73	0.38~3.15	0.62~3.88	0.71~4.38	
C.O.P		7.2~4.8	7.1~4.7	7.0~4.6	6.9~4.6	7.3~4.9	7.2~4.8	
Power Supply		220-240/1/50					380-415/3/50	
Connection Type		10amp	10amp	15amp	hardwired	hardwired	hardwired	
Compressor Quantity		1	1	1	1	1	1	
Compressor Type		rotary	rotary	rotary	rotary	rotary	rotary	
Fan Number		1	1	1	1	1	1	
Fan Power Input	W	40	40	40	40	40	40	
Fan Rotate Speed	RPM	400-800	400-800	400-800	300-750	300-750	300-750	
Fan Direction		horizontal	horizontal	horizontal	horizontal	horizontal	horizontal	
Noise (1M)	dB(A)	39-50	41-52	42-53	43-54	49-56	47-55	
Water Connection	mm	40	40	40	40	40	40	
Flow Rate	L/min	53	67	87	100	173	200	
Water Pressure Drop (max)	kPa	4.0	3.0	4.0	5.0	10.4	12.0	
Net Dimensions (LxWxH)	mm	999 x 418 x 605		1044 x 453 x 768	1158 x 467 x 862	1159 x 490 x 858		

***Please note: Information is correct at the time of printing and may be liable to change at any time without notice.**

Heating: Outdoor air temp: 27°C/24.3°C | Inlet water temp: 26°C
 Outdoor air temp: 15°C/12°C | Inlet water temp: 26°C

Operating Range: Ambient Temperature: -7-43°C | Water temperature: 9-40°C

2.2 DIMENSIONS

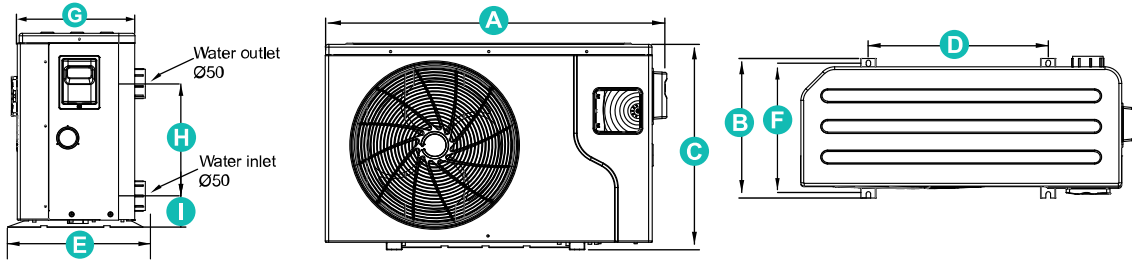

GE-9 & GE-12

Unit: mm	A (L)	B (W)	C (H)	D	E	F	G	H	I
	999	418	605	535	418	389	364	350	98

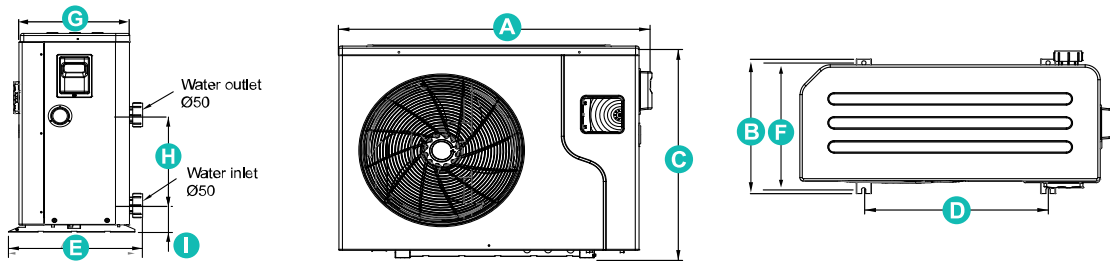

GE-16

Unit: mm	A (L)	B (W)	C (H)	D	E	F	G	H	I
	1044	453	768	615	453	428	396	348	103

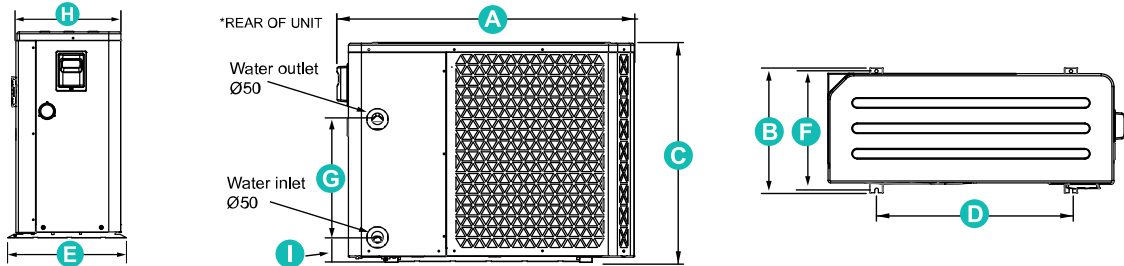

GE-20

Unit: mm	A (L)	B (W)	C (H)	D	E	F	G	H	I
	1159	490	862	758	490	467	465	435	98

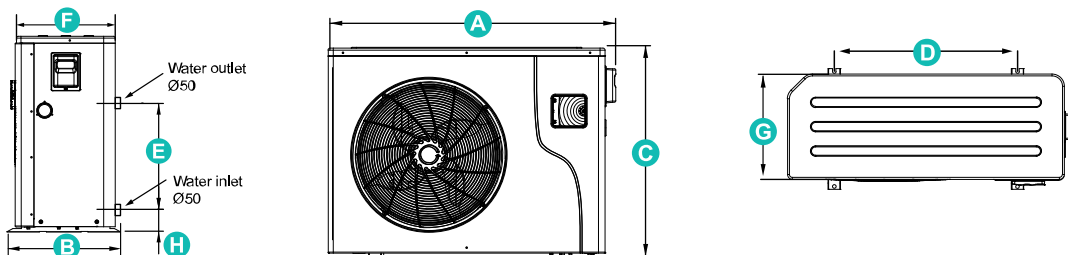

GE-24 & GE-28T

Unit: mm	A (L)	B (W)	C (H)	D	E	F	G	H
	1159	490	858	738	466	428	428	96.2

3. INSTALL & CONNECTION

3.1 INSTALLATION DIAGRAM

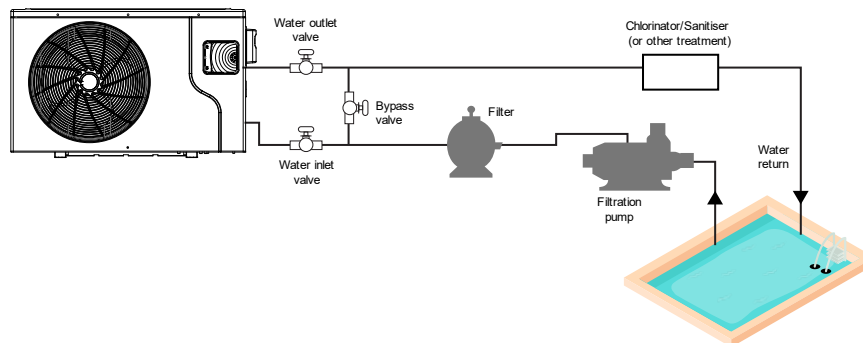

Note: Diagram is for reference only.

The Heat Pump can be installation can be configured with a bypass system to enable operation of the filtration and sanitation systems to continue while the heat pump is not in use.

Upon receiving your unit you will also receive 1x Instruction Manual, 2x Connectors, 2x Rubber Rings & 4x Rubber Feet.

When using the unit for the first time:

- Open the water valves.
- Make sure that the pump and the water-in pipe have been filled with water.
- Close the valve and start the unit.

Note: It is necessary that the water-in pipe is higher than the pool's surface.

3.2 LOCATION OF INSTALLATION

Note: as per the diagram, you need to have clearances of: 1500mm at the front, 300mm at the rear, 500mm at the top of the unit, and 700mm on both sides.

DO NOT place the unit in an enclosed area or room to prevent the discharge air being recirculated.

DO NOT place the unit near shrubs that may grow and block the air inlet.

Placing the unit in a location where the unit is denied a continuous source of fresh air will reduce efficiency and may prevent adequate heat delivery.

The heat pump should be installed as close as possible to filtration equipment. The longer the distance from the pool, the greater the heat loss from the piping.

Majority of the piping is usually buried, therefore the heat loss is minimal for runs of up to 15 metres (each way, 30 in total) unless the ground is wet or the water table is high. A very rough estimate of heat loss per 30 metres is 0.6kW an hour for every 5°C difference in temperature between the pool water and the ground surrounding the pipe, translating to roughly 3% to 5% increase in run time.

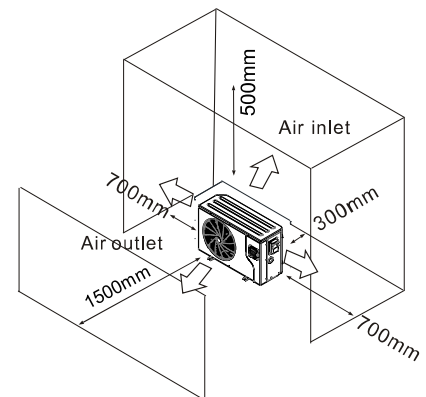

3.3 PLUMBING OF THE UNIT

The titanium heat exchanger of the unit requires no special plumbing arrangements. The water pressure drop is less than 10kPa at maximum flow rate. Since there is no residual heat or flame temperatures, the unit doesn't require copper heat sink piping. PVC pipe can be ran straight into the unit.

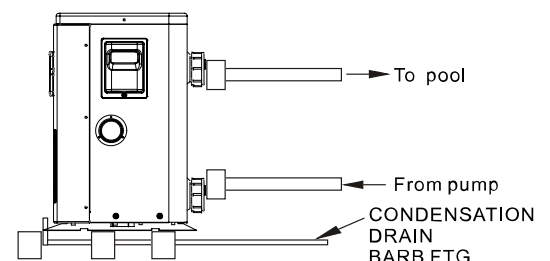

LOCATION: Connect the unit in the pool pump discharge (return) line downstream of all filter and pool pumps, and upstream of any chlorinators, ozonators or chemical pumps.

Standard models have slip glue fittings which accept 40mm or 50mm PCV pipe for connection to the pool or spa filtration plumbing. By using a 50mm to 40mm reducer you can plumb 40mm.

CONDENSATION: Since the heat pump cools down the air from 4-5°C, water may condense on the fins of the evaporator. If the relative humidity is very high, this could be multiple litres per hour. The water will run down the fins into the basepan and drain out through the barbed plastic condensation drain fitting on the side of the basepan. This fitting is designed to accept 20mm clear vinyl tubing which can be pushed on by hand and ran to a suitable drain. It is very easy to mistake the condensation for a leak inside the unit.

NB: A quick way to determine if the water is condensation is to shut off the unit while keeping the pool pump running. If water stops running out of the basepan then it is condensation. Another way is to test the drain water for chlorine, if there is no chlorine present then it is condensation.

3.4 ELECTRICAL WIRING

Note: Although the unit's heat exchanger is electrically isolated from the rest of the unit, it simply prevents the flow of electricity to or from the pool water. Grounding the unit is still required to protect you against short circuits inside the unit. Bonding is also required.

The unit has a separate molded-in junction box with a standard electrical conduit nipple already in place. Just remove the screws and the front panel, feed your supply lines in through the conduit nipple and wire-nut the electric supply wires to the three connections already in the junction box (four connections if three phase). To complete the electrical hookup, connect the heat pump by electrical conduit, UF cable or another suitable means as specified (as permitted by local electrical authorities) to a dedicated AC power supply branch circuit equipped with the proper circuit breaker, disconnect or time delay fuse protection.

DISCONNECT: A disconnect means (circuit breaker, fused or un-fused switch) should be located within sight of and readily accessible from the unit. This is common practice on commercial or residential air conditioners and heat pumps. It prevents remotely-energising unattended equipment and permits turning off power at the unit while it is being serviced.

3.5 FIRST TIME STARTUP

Note: In order for the unit to heat the pool or spa the filter pump must be running to circulate water through the heat exchanger.

STARTUP PROCEDURE

(After installation has been completed follow these steps)

1. Turn on the filter pump. Check for water leaks and verify flow to and from the pool.
2. Turn on the electrical power supply to the unit, then press the ON/OFF key on the controller. The unit should start within a few seconds.
3. After running for a few minutes ensure the air leaving the unit is cooler (between 5-10°C)
4. With the unit operating turn the filter pump off. The unit should also turn off automatically.
5. Allow the unit and pool pump to run 24hrs per day until the desired water temperature is reached at which point the compressor will slow down to maintain temperature.







TIME DELAY

The heat pump is equipped with a time delay, this prevents the unit from short cycling. The fan will always start first, followed by the compressor.













4. USE & OPERATION

4.1 THE CONTROL PANEL



	POWER	Start or shut down the unit, cancel the current operation, return to the previous menu.
	MODE	Switch between unit modes, temperature settings & parameter settings.
	CLOCK	User clock & timer settings.
	SILENT	Turn on or off the silent function OR set a silent timer function.
	UP	Scroll up or increase value.
	DOWN	Scroll down or decrease value.

Icons Explained

	Cooling	Displays during cooling		Water outlet	Water outlet temperature
	Heating	Displays during heating		Water inlet	Water inlet temperature
	Automatic	Displays under auto mode		Lock	Displays when keyboard is locked
	Defrosting	Displays during defrosting		Fault	Displays when a fault occurs
	Silent	Indicates silent status		Degrees	Indicates temperature in Celsius
	Timing	Timing periods that can be set		Setting	Parameter is adjustable

4.2 USING THE CONTROL PANEL

4.2.1 ON/OFF MODE

The heat pump will display 'OFF' on the screen while the unit is not turned on. When it has been turned on, the water inlet temperature is displayed on the screen.

Simply press the **POWER** button for half a second to turn the unit on or off.

4.2.2 SWITCHING MODES

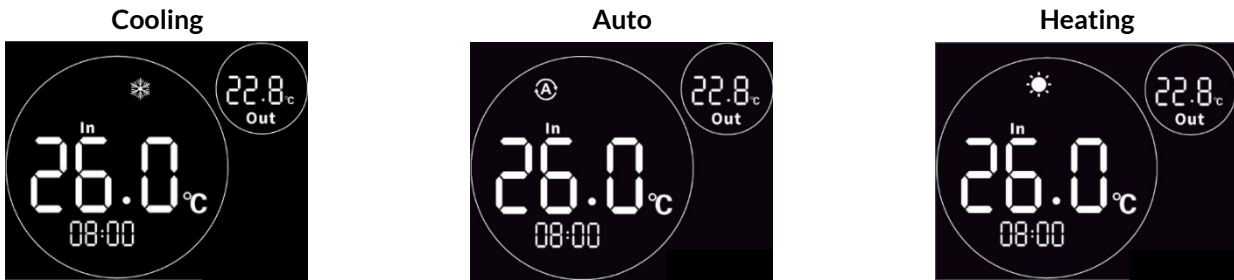

From the main menu, press the **MODE** button to switch the unit among heating, cooling and automatic mode. The mode change will automatically save after 2 seconds of idle operation.

Note: When the unit is in Defrosting mode, the defrosting symbol will appear on the screen. Upon completing the defrosting, the unit automatically switches to heating/automatic mode.

4.2.3 SMART, BOOST & ECO MODES

Under either the Cooling or Heating modes, there are 3 different 'sub-modes' of frequency operation.

- Smart mode will automatically choose whether the unit needs to run in boost or eco modes.
- Boost mode will get your unit to the target temperature faster.
- Eco mode will run the unit at a reduced rate to save power consumption. It may take slightly longer to reach the target temperature.

To enter the sub-modes menu, first ensure you are on either Cooling or Heating mode on the main screen. Press and hold the **DOWN (-)** button for 3 seconds to enter the sub-menu.

A screen will appear with one of the following symbols: **b** (Boost), **S** (Smart), **E** (Eco). Use the **UP (+)** and **DOWN (-)** keys to select the desired mode. To save the mode setting, either leave the screen idle for 5 seconds or press the **MODE** button. Press the **POWER** button to cancel changes and return to the main menu.

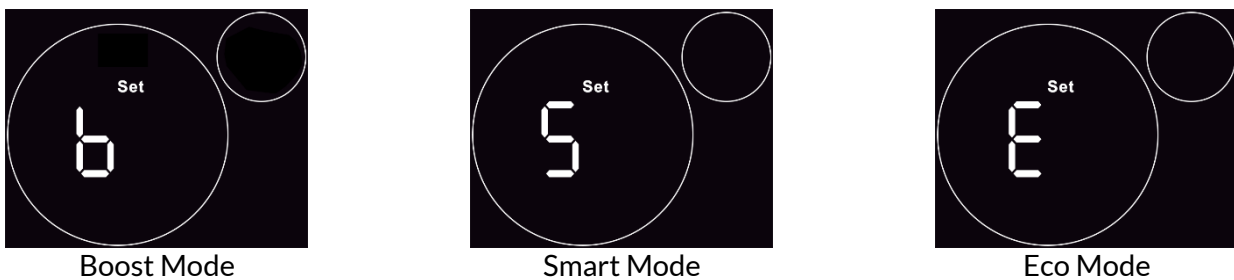

4.2.3 SETTING THE TEMPERATURE

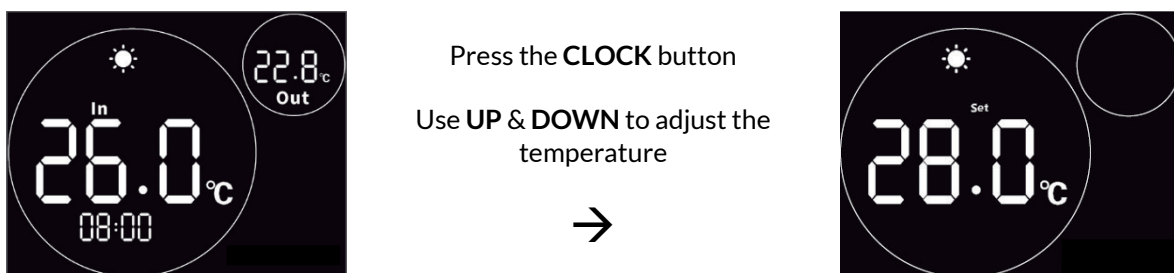

To change the set temperature of the unit, simply press the **UP** or **DOWN** key. The set temperature will begin to flash when you are altering it. Use the keys to adjust the temperature as required, then let the screen sit idle for 5 seconds to save the changes.

4.2.4 CLOCK SETTINGS

To change the system time of the unit, press the **CLOCK** button, the time will appear.

To set the hour digit, press the **CLOCK** button. The hour value will begin to flash indicating it is currently being edited. Use the + or - keys to adjust the hour value, then press **CLOCK** to save and move onto the minute value.

When the minute value is flashing, press the + or - arrows again, pressing **CLOCK** and then **POWER** again to save your changes.



Press **CLOCK**

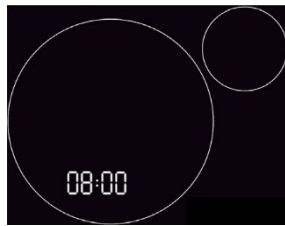

Press **CLOCK**
The hour will begin to flash

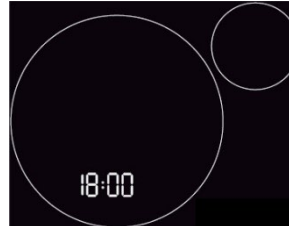

Adjust the hour then press **CLOCK** to adjust minute

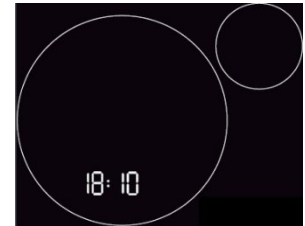

Adjust minutes then press **CLOCK** then **POWER** to save

4.2.5 TIMER SETTINGS

4.2.5.1 SETTING ON/OFF TIMER



Hold **CLOCK** to enter timer settings

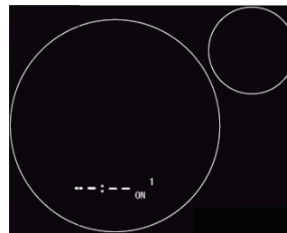

Select a timer using the arrow keys, then **CLOCK** to adjust time.

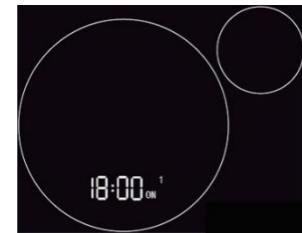

The hour digit will be flashing indicating is changeable

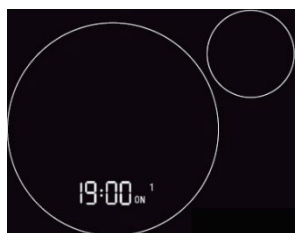

Use arrow keys to adjust hour, then **CLOCK** to save and adjust minutes.

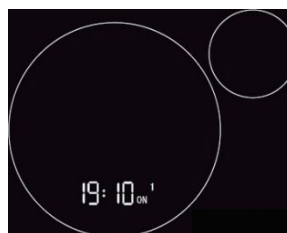

The hour digit will now be flashing indicating is changeable.

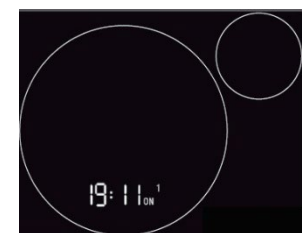

Adjust the minutes then press **CLOCK** to finish setting timer. Press **CLOCK** again to save and head back to main menu.

Note: 2 different timer periods can be set (ON1-OFF1 & ON2-OFF2).

If you wish to set a timer for your unit, you first need to enter into the **CLOCK** setting interface by pressing the **CLOCK** button once. To then enter into the timer setting menu, hold the **CLOCK** button for 2 seconds.

You will enter the beginning of the timer menu where you can first select which timer you would like to set. Use the arrow keys to select from ON1, OFF1, ON2 or OFF2.

Once you have selected the timer you wish to edit, press the **CLOCK** button.

Use the **UP** and **DOWN** keys to adjust the hour value, then press the **CLOCK** button to edit the minute value. Once you have set the minute value, press the **CLOCK** button to save the selected timer. To exit the timer menu, press the **CLOCK** button a final time.

4.2.5.2 CANCELLING TIMER

In the timer setting interface, with either the hour or minute digit flashing, press the **POWER** button to cancel the setting.

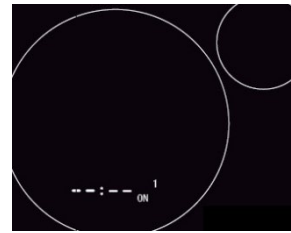
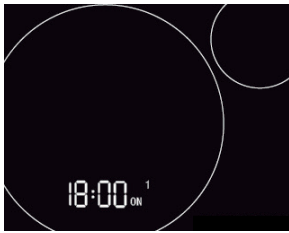

With hour or minute digit flashing, press **POWER** to cancel timer.

4.2.6 SILENT SETTINGS

4.2.6.1 SETTING A SILENT TIMER

From the main menu, press and hold the **SILENT** key for 2 seconds. This menu will allow you to set a single timing period of reduced noise from the unit.

Using the same method as adjusting the on/off timers, you can set an on & off time.

Note: Only the start and end hour can be set.

4.2.6.2 ONE-CLICK SILENT

Press the **SILENT** button to enable or disable the silent function. When the silent function is enabled, the icon on the screen will display with 3 blades (When the function is not on, the fan appears with all blades).



Silent Mode OFF



Silent Mode ON

4.2.7 KEYBOARD LOCK

To lock or unlock the controller simply hold the **POWER** button for 5 seconds. A small lock symbol will appear and flash on the main screen when the unit is locked.

4.2.8 FAULT INTERFACE

If a failure occurs, the controller will display a code that corresponds to a specific error. Refer to the fault table for definitions of the fault codes.

If multiple failures occur at once, use the **UP** or **DOWN** keys to scroll between them.

To minimise the fault window and view the main menu, press the **POWER** button once.



- 1** Quantity of fault/s
- 2** Fault serial number
- 3** Fault code

4.3 TROUBLESHOOTING GUIDE

Electronic Control Fault Table

Malfunction	Display	Cause	Solution
Inlet temp. sensor fault	P01	The temp. sensor is broken or short circuit	Check or change the temp. sensor
Outlet temp. sensor Fault	P02	The temp. sensor is broken or short circuit	Check or change the temp. sensor
Ambient temp. sensor Fault	P04	The temp. sensor is broken or short circuit	Check or change the temp. sensor
Coil 1 temp. sensor fault	P05	The temp. sensor is broken or short circuit	Check or change the temp. sensor
Coil 2 temp. sensor fault	P15	The temp. sensor is broken or short circuit	Check or change the temp. sensor
Suction temp. sensor Fault	P07	The temp. sensor is broken or short circuit	Check or change the temp. sensor
Discharge temp. sensor Fault	P081	The temp. sensor is broken or short circuit	Check or change the temp. sensor
Exhaust air over temp prot.	P082	The compressor is overload	Check whether the system of the compressor running normally
Antifreeze temp. sensor fault	P09	Antifreeze temp sensor is broken or short circuited	Check and replace this temp sensor
Pressure sensor fault	PP	The pressure sensor is broken	Check or change the pressure Sensor or pressure
High pressure prot.	E01	The high-pressure switch is broken	Check the pressure switch and cold circuit
Low pressure prot.	E02	Low pressure1 protection	Check the pressure switch and cold circuit
Flow switch prot.	E03	No water/little water in water system	Check there is water flow to pool. If there is flow, flow switch needs changing
Waterway anti-freezing prot.	E05	Water temp. or ambient temp. is too low	
Inlet and outlet temp. too big	E06	Water flow is not enough and low differential pressure	Check the pipe water flow and whether water system is jammed or not
Anti-freezing prot.	E07	Water flow is not enough	Check the pipe water flow and whether water system is jammed or not
Primary anti-freezing prot.	E19	The ambient temp. is low	
Secondary anti-freezing prot.	E29	The ambient temp. is low	
Comp. overcurrent prot.	E051	The compressor is overload	Check whether the system of the compressor running normally
Communication fault	E08	Communication failure between wire controller and mainboard	Check the wire connection between remote wire controller and main board
Communication fault (speed control module)	E081	Speed control module and main board communication fail	Check the communication connection
Low AT protection	TP	Ambient temp is too low	
EC fan feedback fault	F051	There is something wrong with fan motor and fan motor stops running	Check whether fan motor is broken or locked or not
Fan motor1 fault	F031	Motor is in locked-rotor state The wire connection between DC-fan motor module and fan motor is in bad contact	Change a new fan motor Check the wire connection and make sure they are in good contact
Fan motor2 fault	F031	Motor is in locked-rotor state The wire connection between DC-fan motor module and fan motor is in bad contact	Change a new fan motor Check the wire connection and make sure they are in good contact

Frequency Conversion Board Fault Table

Protection/fault	Fault display	Reason	Elimination methods
Drv1 MOP alarm	F01	MOP drive alarm	Recovery after the 150s
Inverter offline	F02	Frequency conversion board and mainboard communication failure	Check the communication connection
IPM protection	F03	IPM modular protection	Recovery after the 150s
Comp. driver failure	F04	Lack of phase, step or drive hardware damage	Check the measuring voltage check frequency conversion board hardware
DC Fan fault	F05	Motor current feedback open circuit or short circuit	Check whether current return wires connected motor
IPM Overcurrent	F06	IPM Input current is large	Check and adjust the current measurement
Inv. DC Overvoltage	F07	DC bus voltage>Dc bus over-voltage protection value	Check the input voltage measurement
Inv. DC Less voltage	F08	DC bus voltage<Dc bus over-voltage protection value	Check the input voltage measurement
Inv. input less volt.	F09	The input voltage is low, causing the input current is high	Check the input voltage measurement
Inv. input overvolt.	F10	The input voltage is too high, more than outage protection current RMS	Check the input voltage measurement
Inv. Sampling Volt.	F11	The input voltage sampling fault	Check and adjust the current measurement
Comm. Err DSP-PFC	F12	DSP and PFC connect fault	Check the communication connection
Input Over Cur.	F26	The equipment load is too large	
PFC fault	F27	The PFC circuit protection	Check the PFC switch tube short circuit or not
IPM overheating	F15	The IPM module is overheat	Check and adjust the current measurement
Weak magnetic warn	F16	Compressor magnetic force is not enough	
Inv. input out phase	F17	The input voltage lost phase	Check and measure the voltage adjustment
IPM sampling cur.	F18	IPM sampling electricity is fault	Check and adjust the current measurement
Inv. temp. probe Fail	F19	Sensor is short circuit or open circuit	Inspect and replace the sensor
Inverter overheating	F20	The transducer is overheat	Check and adjust the current measurement
Inv. overheating warn	F22	Transducer temperature is too high	Check and adjust the current measurement
Comp. over cur. warn	F23	Compressor electricity is large	The compress or over-current protection
Input Over Cur. Warn	F24	Input current is too large	Check and adjust the current measurement
EEPROM Error Warn	F25	MCU error	Check whether the chip is damaged Replace the chip
V15V over/undervoltage fault	F28	The V15V is overload or under-voltage	Check the V15V input voltage in range 13.5v~16.5v or not

5. WI-FI OPERATION

5.1 INTRODUCTION

The Guardian Handy Heat Pump app is available as a standard inclusion on the Guardian Lux-V, Platinum & EcoPro series.

Available for iOS and Android, the smart phone controller app offers you an easy and convenient way to monitor and control your pool temperature, as well as adjust settings, set timers, receive error alerts & allow remote access from a technician.

Module Diagram

	NAME	LONG LIGHT	SLOW FLASH
1	Network configuration indicator	Configuring Network	SmartLink configuring
2	Router connection indicator	Normal	Abnormal
3	Cloud server connection indicator	Normal	Abnormal
4	485 communication indicator	Normal	Abnormal
5	Configuration button		

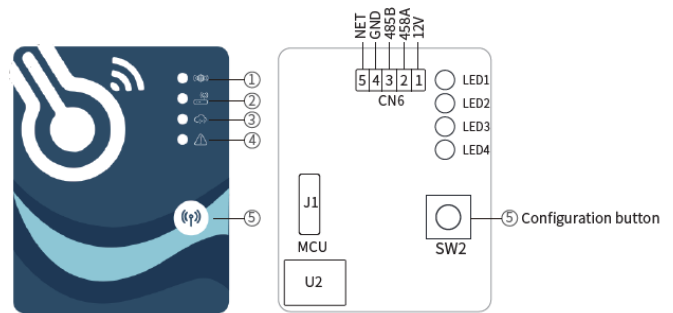

Troubleshooting:

Ensure that you are connecting to a 2.4GHZ network, not a 5GHZ network. If you are unsure, contact your network provider.

Ensure you are not connecting to a Wi-Fi booster or extender, connection must be made to the modem directly.



Check signal strength and distance between the heater and the modem is not more than 10m. If possible, try moving your modem closer to test the connection.

(If issues occur) Try using a different mobile device with a different software version to ensure you have no compatibility issues.

5.2 INSTALLATION

There is a magnet on the back on the wi-fi module which holds it in place on the heat pump. Where possible, the module should be placed on the unit in a location where it receives the least direct sunlight and away from other weather elements.

To download the app, head to your device's app store and search 'Handy Heat Pump' or scan the QR code below.

APPLE	ANDROID
	
CLICK HERE	CLICK HERE

5.3 APP SETUP

5.3.1 CREATE AN ACCOUNT

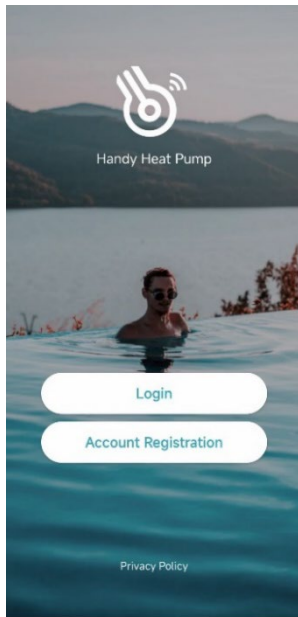

Fig. 2: Home Page

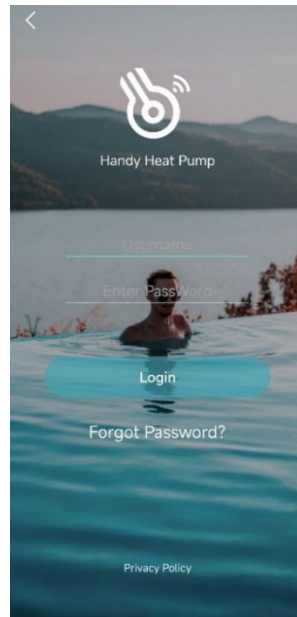

Fig. 1: Login Menu

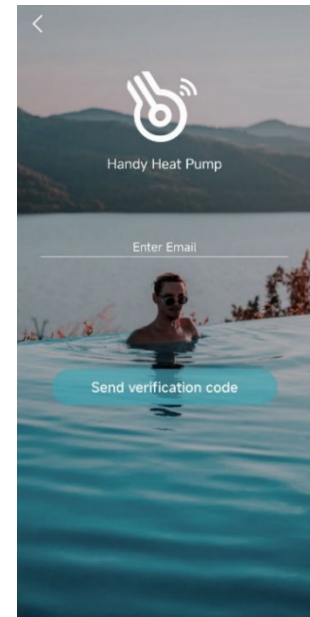

Fig. 3: Forgot Password Menu

1. You need to create an account to use the app. To register, press the Account Registration button & fill in your details.
2. Press the button next to 'Enter Email Verification' to send a code to your email (ensure you check your Junk folder). Once you have this code, go back into the app and enter the code into the field.

Set a new password for your account to finish registering your account.

Note: the verification code is only valid for 15 minutes, after this time you will need to request a new one.

3. From the login page (Fig.1) enter your registered email and password and then press Login. If you forget your password, you can head to the Forgot Password screen and follow the prompts.

5.3.2 ADD YOUR DEVICE & CONFIGURE WI-FI

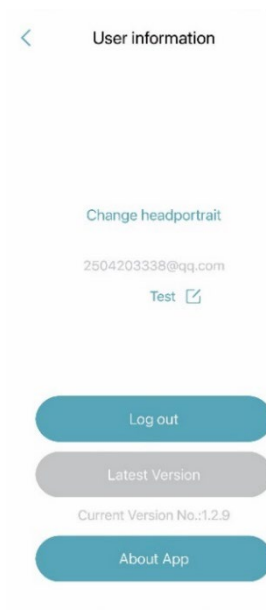

Fig. 5: Left-Hand Menu

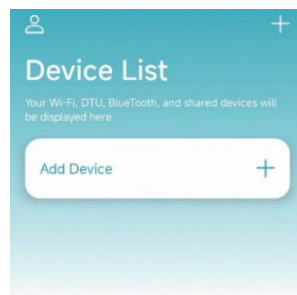

Fig. 4: My Device Menu



Fig. 6: Add Device Menu

Once you have logged in, you will enter the My Device screen (Fig.4) where you can add your device and set up the wi-fi connection.

Note: ensure your Bluetooth is turned on in your phone settings and enabled in the app settings. The app will ask for permission to use Location, Camera & Bluetooth, ensure you always allow these as the app requires them to function.

1. To add your device, press the **+** button in the top right corner and then select the **BOTTOM** Wi-Fi option (Fig. 6).
2. Press and hold the button on the Wi-Fi module for a second until two lights turn on. This means the AP connection is activated and ready to connect. Press 'Next' (Fig. 7).
3. Enter your home router's Wi-Fi password then press OK (ensure it is correct!). The app will now search for your device, you may need to sit near the heat pump during this process (Fig. 8-9)



Fig. 7: Wi-Fi Module On Menu

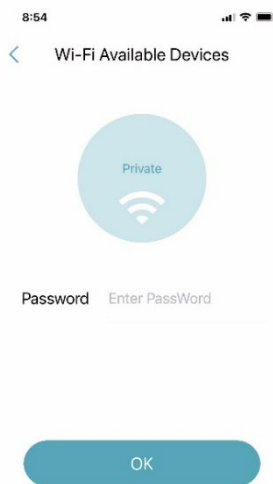

Fig. 8: Enter Wi-Fi Password

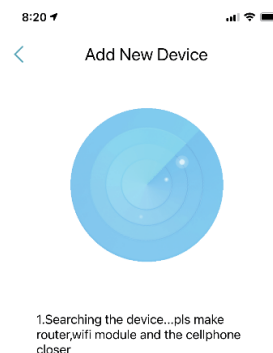

Fig. 9: Searching for Device

4. Once your device has been recognised (Fig. 10) you will then need to link your device using the barcode (Fig. 11 – 12). You can either use the camera to scan the barcode or enter it manually, the correct barcode will start with a WF.

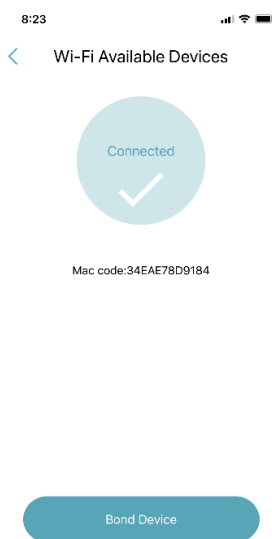

Fig. 10: Device Bonded

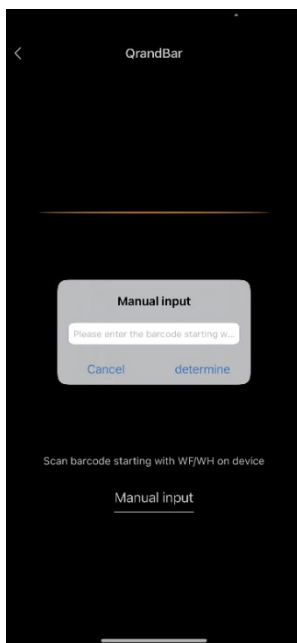

Fig. 11: Manually Input Barcode

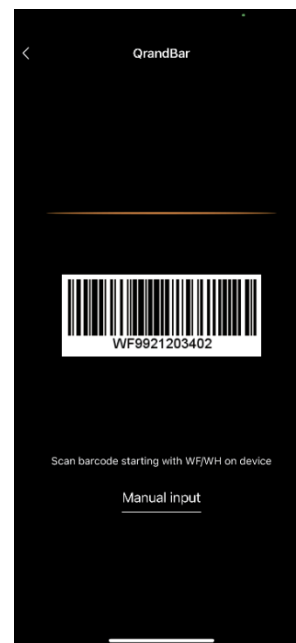

Fig. 12: Scan Barcode

- Once you have linked the correct barcode, you can complete the connection and name your device if required (e.g. Holiday Home Heater).
- Once complete, you will enter the device management menu (Fig. 14) where you can go into the unit to view and adjust the settings.

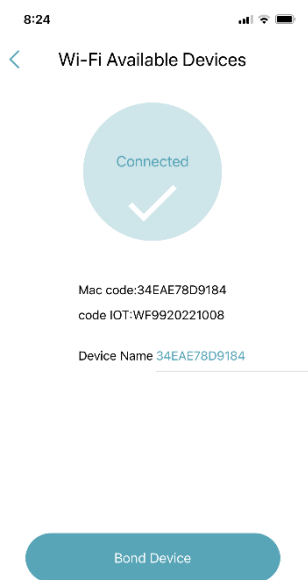

Fig. 13: Connection Complete

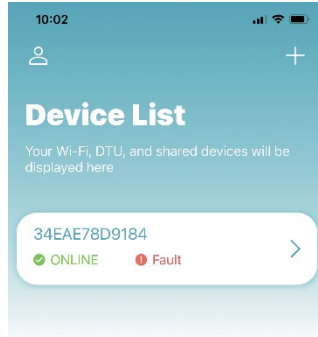

Fig. 14: Device Management

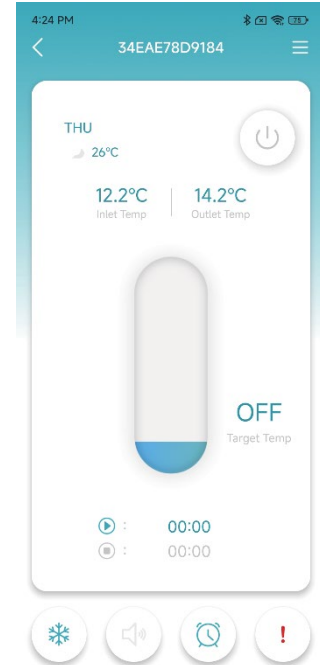









Fig. 15: Device Main Menu

5.3.3 DEVICE MANAGEMENT

Once Wi-Fi and Bonding has been completed, enter the 'My Device' menu to access a range of functions.

ICON	NAME	FUNCTIONS
	ON/OFF	Turn the unit on or off
	SILENT MODE (OFF)	Silent mode is not activated
	SILENT MODE (ON)	Silent mode has been activated.
	COOLING	Cooling mode, press to select a different mode.
	HEATING	Heating mode, press to select a different mode.
	AUTO	Auto mode, press to select a different mode.
	TIMER SETTINGS	Adjust timer on/off & mute timer settings
	TROUBLESHOOTING	View errors

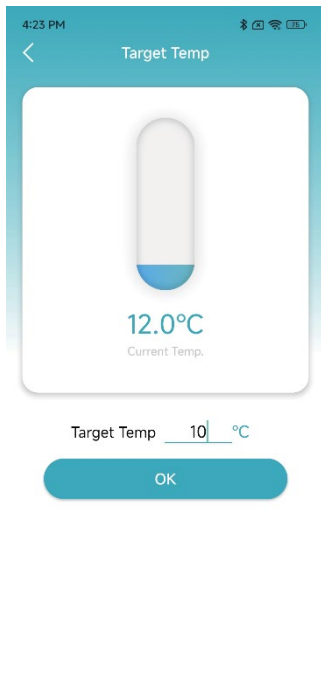

Fig. 16: Modify Target Temperature



Fig. 17: Main Menu

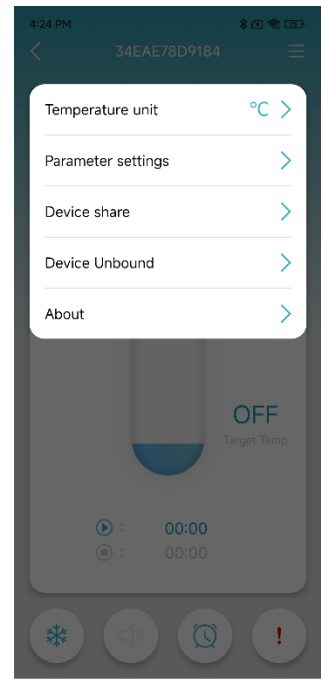

Fig. 18: Right-Hand Menu

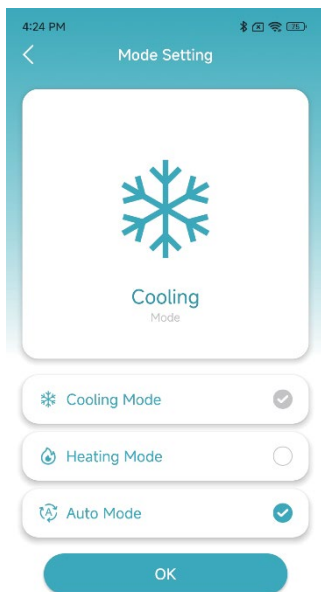

Fig. 19: Mode Menu



Fig. 20: Timer Settings

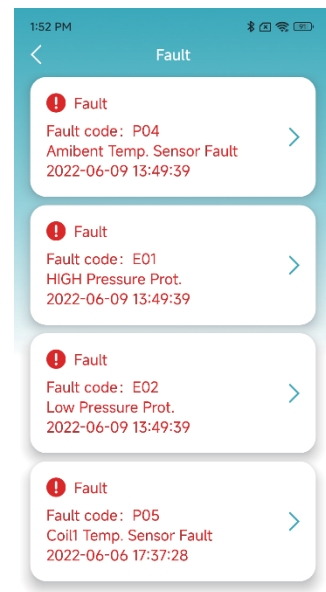

Fig. 21: Troubleshooting Menu

6. MAINTENANCE & INSPECTION

Check that the heat pump has good water flow. Avoid the condition of no water or air entering the system, this will influence unit's performance and reliability.

You should clear the pool/spa filter regularly to avoid damage to the unit as a result of the dirty or clogged filter.

The area around the unit should be dry, clean and well ventilated. Clean the side heating exchanger regularly to maintain good heat exchange.

The operation pressure of the refrigerant system should only be serviced by a certified technician.

Check the power supply and cable connection often, should the unit begin to operate abnormally, switch it off and contact a qualified technician.

CHECKS TO THE AREA

Prior to beginning work on systems containing flammable refrigerants, safety checks are necessary to ensure that the risk of ignition is minimised. For repair to the refrigerating system, the following precautions shall be complied with prior to conducting work on the system.

WORK PROCEDURE

Work shall be undertaken under a controlled procedure to minimise the risk of a flammable gas or vapour being present while the work is being performed.

GENERAL WORK AREA

All maintenance staff and others working in the local area shall be instructed on the nature of work being carried out. Work in confined spaces should be avoided. The area around the workspace should be sectioned off. Ensure that the conditions within the area have been made safe by control of flammable material.

CHECKING FOR PRESENCE OF REFRIGERANT

The area should be checked with an appropriate refrigerant detector prior to and during work, to ensure the technician is aware of potentially flammable atmospheres. Ensure that the leak detection equipment being used is suitable for use with flammable refrigerants, i.e. non-sparking, adequately sealed or intrinsically safe.

PRESENCE OF FIRE EXTINGUISHER

If any hot work is to be conducted on the refrigeration equipment or any associated parts, appropriate fire extinguishing equipment shall be available to hand. Have a dry powder or CO2 fire extinguisher adjacent to the charging area.

NO IGNITION SOURCES

No person carrying out work in relation to a refrigeration system which involves exposing any pipe work that contains or has contained flammable refrigerant shall use any sources of ignition in such a manner that it may lead to the risk of fire or explosion. All possible ignition sources, including cigarette smoking, should be kept sufficiently far away from the site of installation, repairing, removing and disposal, during which flammable refrigerant can possibly be released to the surrounding space. Prior to work taking place, the area around the equipment is to be surveyed to make sure that there are no flammable hazards or ignition risks. No Smoking signs shall be displayed.

VENTILATED AREA

Ensure that the area is in the open or that it is adequately ventilated before breaking into the system or conducting any hot work. A degree of ventilation shall continue during the period that the work is carried out. The ventilation should safely disperse any released refrigerant and preferably expel it externally into the atmosphere.

CHECKS TO THE REFRIGERATION EQUIPMENT

Where electrical components are being changed, they shall be fit for the purpose and to the correct specification. At all times the manufacturer's maintenance and service guidelines shall be followed. If in doubt consult the manufacturer's technical department for assistance.

The following checks shall be applied to installations using flammable refrigerants:

- The charge size is in accordance with the room size within which the refrigerant containing parts are installed;
- The ventilation machinery and outlets are operating adequately and are not obstructed; If an indirect refrigerating circuit is being used, the secondary circuit shall be checked for the presence of refrigerant;
- Marking to the equipment continues to be visible and legible. Markings and signs that are illegible shall be corrected;
- Refrigeration pipe or components are installed in a position where they are unlikely to be exposed to any substance which may corrode refrigerant containing components, unless the components are constructed of materials which are inherently resistant to being corroded or are suitably protected against being so corroded.

CHECKS TO ELECTRICAL DEVICES

Repair and maintenance to electrical components must include initial safety checks and component inspection procedures. If a fault exists that could compromise safety, then no electrical supply should be connected to the circuit until it is satisfactorily dealt with. If the fault cannot be corrected immediately but it is necessary to continue operation, an adequate temporary solution is to be used. This must be reported to the owner of the equipment so all parties are advised.

Initial safety checks shall include:

- That capacitors are discharged: this must be done in a safe manner to avoid possibility of sparking;
- That there no live electrical components and wiring are exposed while charging, recovering or purging the system;
- That there is continuity of earth bonding.

REPAIRS TO SEALED COMPONENTS

- 1) During repairs to sealed components, all electrical supplies shall be disconnected from the equipment being worked upon prior to any removal of sealed covers, etc. If it is absolutely necessary to have an electrical supply to equipment during servicing, then a permanently operating form of leak detection must be located at the most critical point to warn of a potentially hazardous situation.
- 2) Particular attention must be paid to the following to ensure that by working on electrical components, the casing is not altered in such a way that the level of protection is affected. This must include damage to cables, excessive number of connections, terminals not made to original specification, damage to seals, incorrect fitting of glands, etc.

ENSURE THAT APPARATUS IS MOUNTED SECURELY.

Ensure that seals or sealing materials have not degraded such that they no longer serve the purpose of preventing the ingress of flammable atmospheres. Replacement parts must be in accordance with the manufacturer's specifications.

NOTE: The use of silicon sealant may inhibit the effectiveness of some types of leak detection equipment. Intrinsically safe components do not have to be isolated prior to working on them.

REPAIR TO INTRINSICALLY SAFE COMPONENTS

Do not apply any permanent inductive or capacitance loads to the circuit without ensuring that this will not exceed the permissible voltage and current permitted for the equipment in use.

Intrinsically safe components are the only types that can be worked on while live in the presence of a flammable atmosphere. The test apparatus must be at the correct rating. Replace components only with parts specified by the manufacturer. Other parts may result in the ignition of refrigerant in the atmosphere from a leak.

CABLING

Check that cabling will not be subject to wear, corrosion, excessive pressure, vibration, sharp edges or any other adverse environmental effects. The check must also take into account the effects of aging or continual vibration from sources such as compressors or fans.

DETECTION OF FLAMMABLE REFRIGERANTS

Under no circumstances should potential sources of ignition be used in the searching for or detection of refrigerant leaks. A halide torch (or any other detector using a naked flame) must not be used.

LEAK DETECTION METHODS

The following leak detection methods are deemed acceptable for systems containing flammable refrigerants.

Electronic leak detectors are to be used to detect flammable refrigerants, but the sensitivity may not be adequate, or may need re-calibration. (Detection equipment must be calibrated in a refrigerant-free area.) Ensure that the detector is not a potential source of ignition and is suitable for the refrigerant used. Leak detection equipment must be set at a percentage of the LFL of the refrigerant and should be calibrated to the refrigerant employed and the appropriate percentage of gas (25 % maximum) is confirmed.

Leak detection fluids are suitable for use with most refrigerants but the use of detergents containing chlorine must be avoided as the chlorine may react with the refrigerant and corrode the copper pipe-work.

If a leak is suspected, all naked flames shall be removed/ extinguished.

If a leakage of refrigerant is found which requires brazing, all of the refrigerant shall be recovered from the system, or isolated (by means of shut off valves) in a part of the system remote from the leak. Oxygen free nitrogen (OFN) shall then be purged through the system both before and during the brazing process.

REMOVAL AND EVACUATION

When breaking into the refrigerant circuit to make repairs or for any other purpose conventional procedures must be used. However, it is important that best practice is followed since flammability is a consideration. The following procedure shall be adhered to:

- Remove refrigerant;
- Purge the circuit with inert gas;
- Evacuate;
- Purge again with inert gas;
- Open the circuit by cutting or brazing.

The refrigerant charge must be recovered into the correct recovery cylinders. The system must be "flushed" with OFN to render the unit safe. This process may need to be repeated several times. Compressed air or oxygen cannot not be used for this task.

Flushing is achieved by breaking the vacuum in the system with OFN and continuing to fill until the working pressure is achieved, then venting to atmosphere, and finally pulling down to a vacuum. This process must be repeated until no refrigerant is within the system. When the final OFN charge is used, the system is to be vented down to atmospheric pressure to enable work to take place. This operation is absolutely vital if brazing operations on the pipe-work are to take place. Ensure that the outlet for the vacuum pump is not close to any ignition sources and there is ventilation available when working on them.

LABELLING

Equipment must be labelled stating that it has been de-commissioned and emptied of refrigerant. The label is to be dated and signed. Ensure that there are labels on the equipment stating the equipment contains flammable refrigerant.

RECOVERY

When removing refrigerant from a system, either for servicing or decommissioning, it is recommended good practice that all refrigerants are removed safely.

When transferring refrigerant into cylinders, ensure that only appropriate refrigerant recovery cylinders are employed. Ensure that the correct number of cylinders for holding the total system charge is available. All cylinders to be used are designated for the recovered refrigerant and labelled for that refrigerant (i.e. special cylinders for the recovery of refrigerant). Cylinders must be complete with pressure relief valve and associated shut- off valves in good working order. Empty recovery cylinders are evacuated and, if possible, cooled before recovery occurs.

The recovery equipment must be in good working order with a set of instructions concerning the equipment that is at hand and shall be suitable for the recovery of flammable refrigerants. In addition, a set of calibrated weighing scales must be available and in good working order. Hoses need to be complete with leak-free disconnect couplings and in good condition. Before using the recovery machine, check that it is in satisfactory working order, has been properly maintained and that any associated electrical components are sealed to prevent ignition in the event of a refrigerant release. Consult manufacturer if in doubt.

The recovered refrigerant needs to be returned to the refrigerant supplier in the correct recovery cylinder, and the relevant Waste Transfer Note arranged. Do not mix refrigerants in recovery units and especially not in cylinders.

If compressors or compressor oils are to be removed, ensure that they have been evacuated to an acceptable level to make certain that flammable refrigerant does not remain within the lubricant. The evacuation process shall be carried out prior to returning the compressor to the suppliers. Only electric heating to the compressor body is to be employed to accelerate this process. When oil is drained from a system, it must be carried out safely.

DECOMMISSIONING

Before carrying out this procedure, it is essential that the technician is completely familiar with the equipment and all its detail. It is recommended good practice that all refrigerants are recovered safely. Prior to the task being carried out, an oil and refrigerant sample shall be taken in case analysis is required prior to re-use of reclaimed refrigerant. It is essential that electrical power is available before the task is commenced.

- a) Become familiar with the equipment and its operation.
- b) Isolate system electrically.
- c) Before attempting the procedure ensure that:
 - Mechanical handling equipment is available, if required, for handling refrigerant cylinders;
 - All personal protective equipment is available and being used correctly;
 - The recovery process is supervised at all times by a competent person;
 - Recovery equipment and cylinders conform to the appropriate standards.
- d) Pump down refrigerant system, if possible.
- e) If a vacuum is not possible, make a manifold so that refrigerant can be removed from various parts of the system.
- f) Make sure that cylinder is situated on the scales before recovery takes place.
- g) Start the recovery machine and operate in accordance with manufacturer's instructions.
- h) Do not overfill cylinders. (No more than 80 % volume liquid charge).
- i) Do not exceed the maximum working pressure of the cylinder, even temporarily.
- j) When the cylinders have been filled correctly and the process completed, make sure that the cylinders and the equipment are removed from site promptly and all isolation valves on the equipment are closed off.
- k) Recovered refrigerant is not be charged into another refrigeration system unless it has been cleaned & checked.

CHARGING PROCEDURES

In addition to conventional charging procedures, the following requirements must be followed.

- Ensure that contamination of different refrigerants does not occur when using charging equipment. Hoses or lines are to be as short as possible to minimise the amount of refrigerant contained in them.
- Cylinders must be kept upright.
- Ensure that the refrigeration system is earthed prior to charging the system with refrigerant.
- Label the system when charging is complete (if not already). Extreme care must be taken not to overfill the refrigeration system.

Prior to recharging the system, it must be pressure tested with OFN. The system needs to be leak tested on completion of charging but prior to commissioning. A follow up leak test should be carried out prior to leaving the site.

The safety wire model is 5*20_5A/250VAC, and must meet explosion-proof requirements

7. APPENDIX

7.1 CABLE SPECIFICATIONS

Cable specifications must meet local regulations and be supplied by a qualified electrician.

7.2 REFRIGERANT SATURATION TEMPERATURE

Comparison table of refrigerant saturation temperature.

Pressure (MPa)	0	0.3	0.5	0.8	1	1.3	1.5	1.8	2	2.3
Temperature (R410A)(°C)	-51.3	-20	-9	4	11	19	24	31	35	39
Temperature (R32)(°C)	-52.5	-20	-9	3.5	10	18	23	29.5	33.3	38.7
Pressure (MPa)	2.5	2.8	3	3.3	3.5	3.8	4	4.5	5	5.5
Temperature (R410A)(°C)	43	47	51	55	57	61	64	70	74	80
Temperature (R32)(°C)	42	46.5	49.5	53.5	56	60	62	67.5	72.5	77.4

7.3 INTERFACE DIAGRAMS

Wire control interface diagram & definitions.

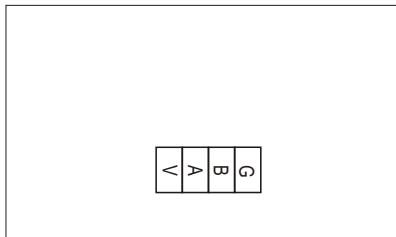

Sign	Meaning
V	12V (power +)
A	485A
B	485B
G	GND (power -)

Controller interface diagram & definitions.

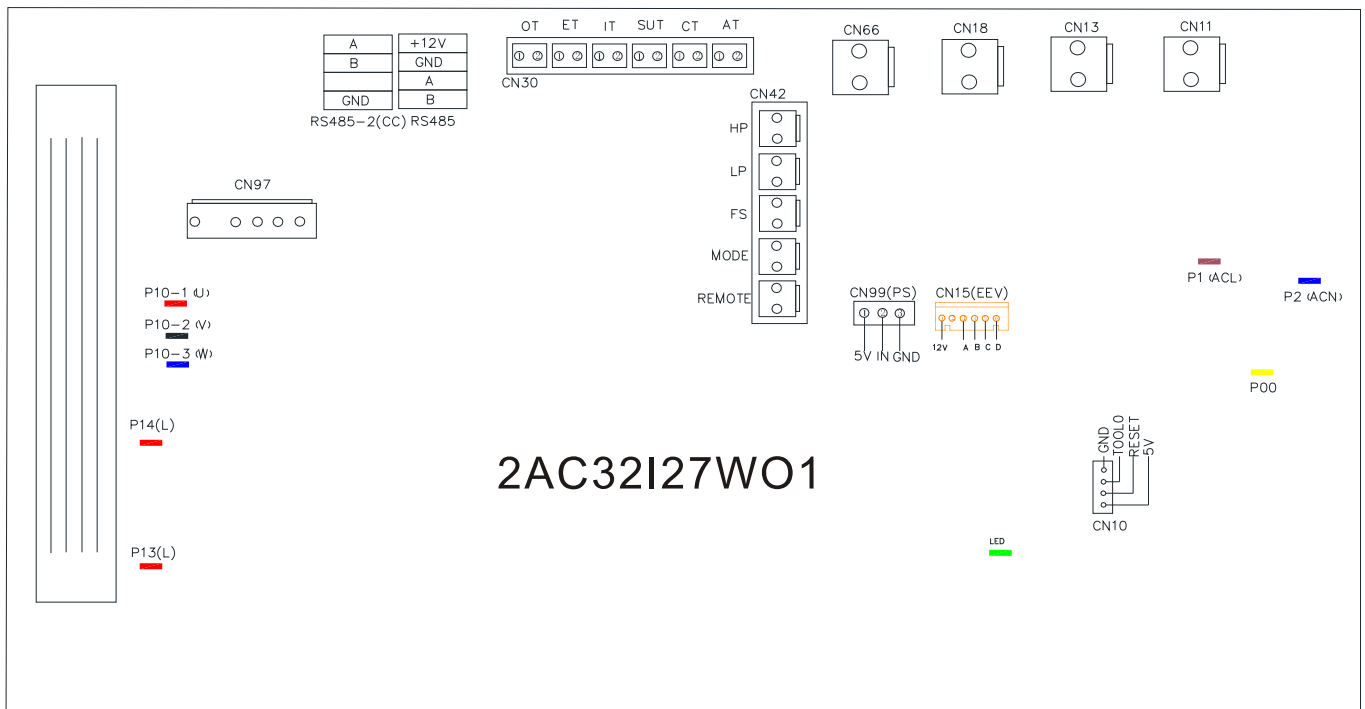

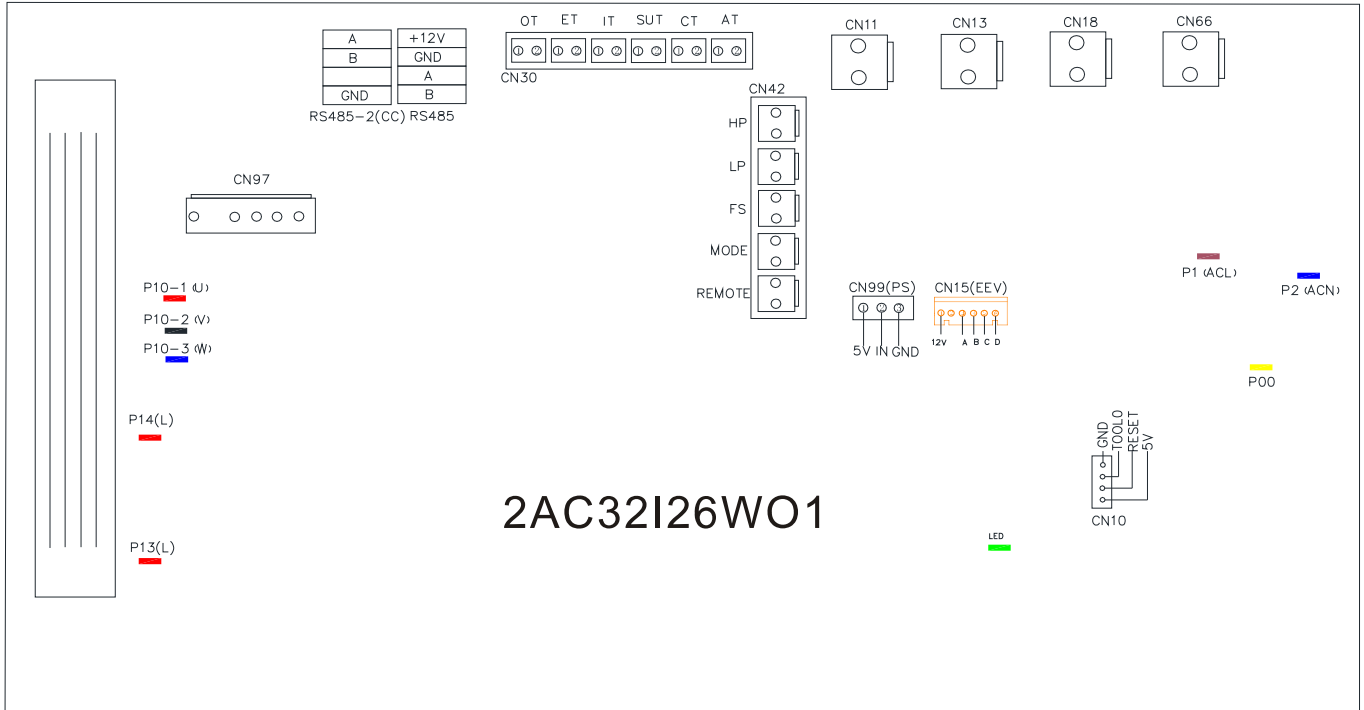

Connections explained:

No.	Sign	Meaning
01	P10-1/2/3(U/V/W)	Compressor
02	CN66	Compressor signal
03	CN97	DC motor
04	CN11	4-way valve
05	CN18	Water pump
06	CN13	Reserved
07	P1 P2	Live wire Neutral wire
08	CN10	Program download interface
09	RS485	Color line controller communication/WiFi
10	RS485-2	The port for centralized control
11	CN15	Electronic expansion valve
12	P13(L)	Resistance
13	P14(L)	Resistance
14	HP	System high pressure
15	LP	System low pressure
16	FS	Water flow switch
17	MODE	Mode switch
18	REMOTE	Emergency switch
19	IT	Water input temperature
20	SUT	System suction temperature
21	CT	System fan coil temperature
22	OT	Water output temperature
23	ET	System exhaust temperature
24	AT	Ambient temperature
25	CN99	Low pressure sensor

7.4 WIRING DIAGRAMS

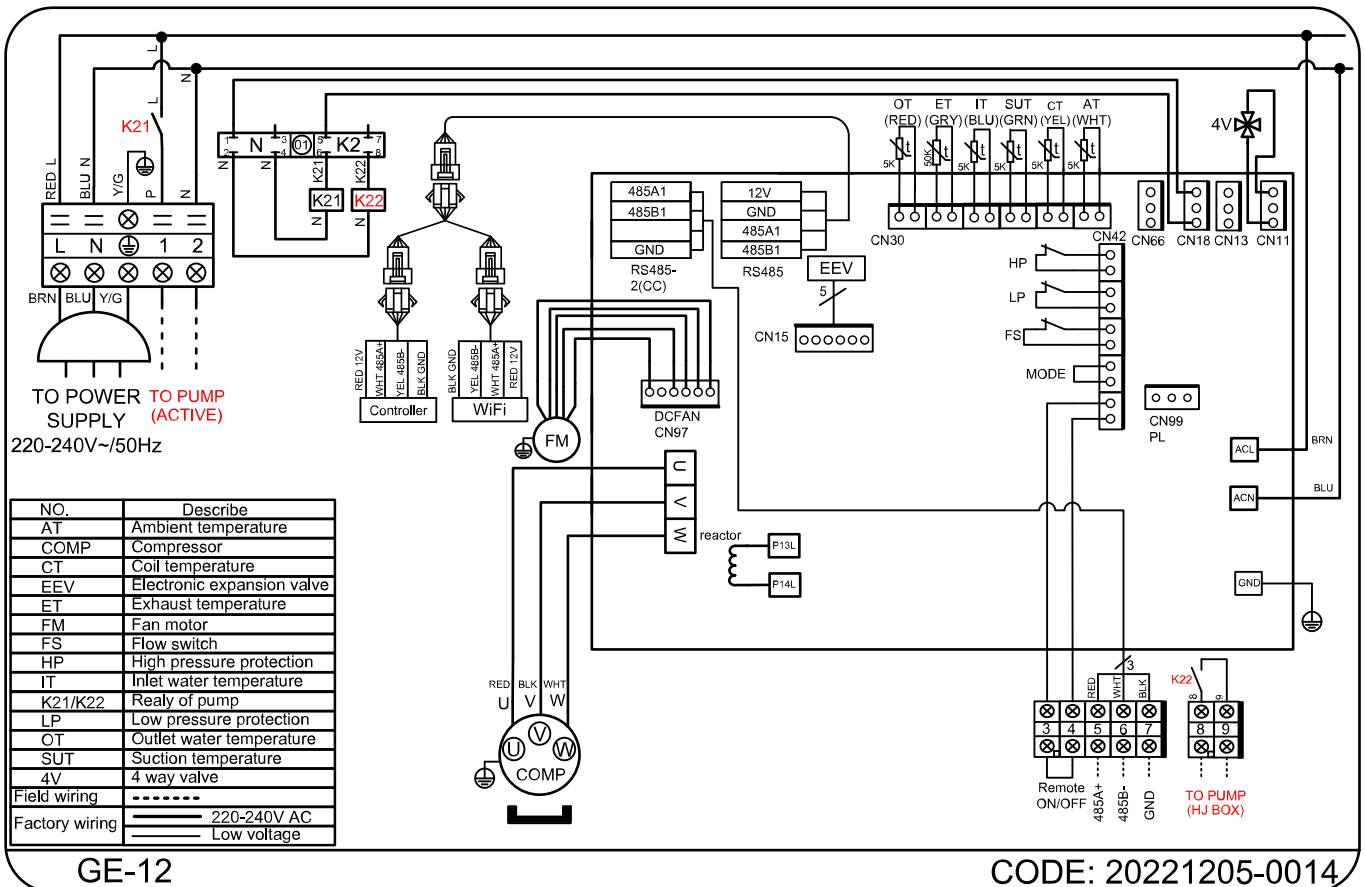
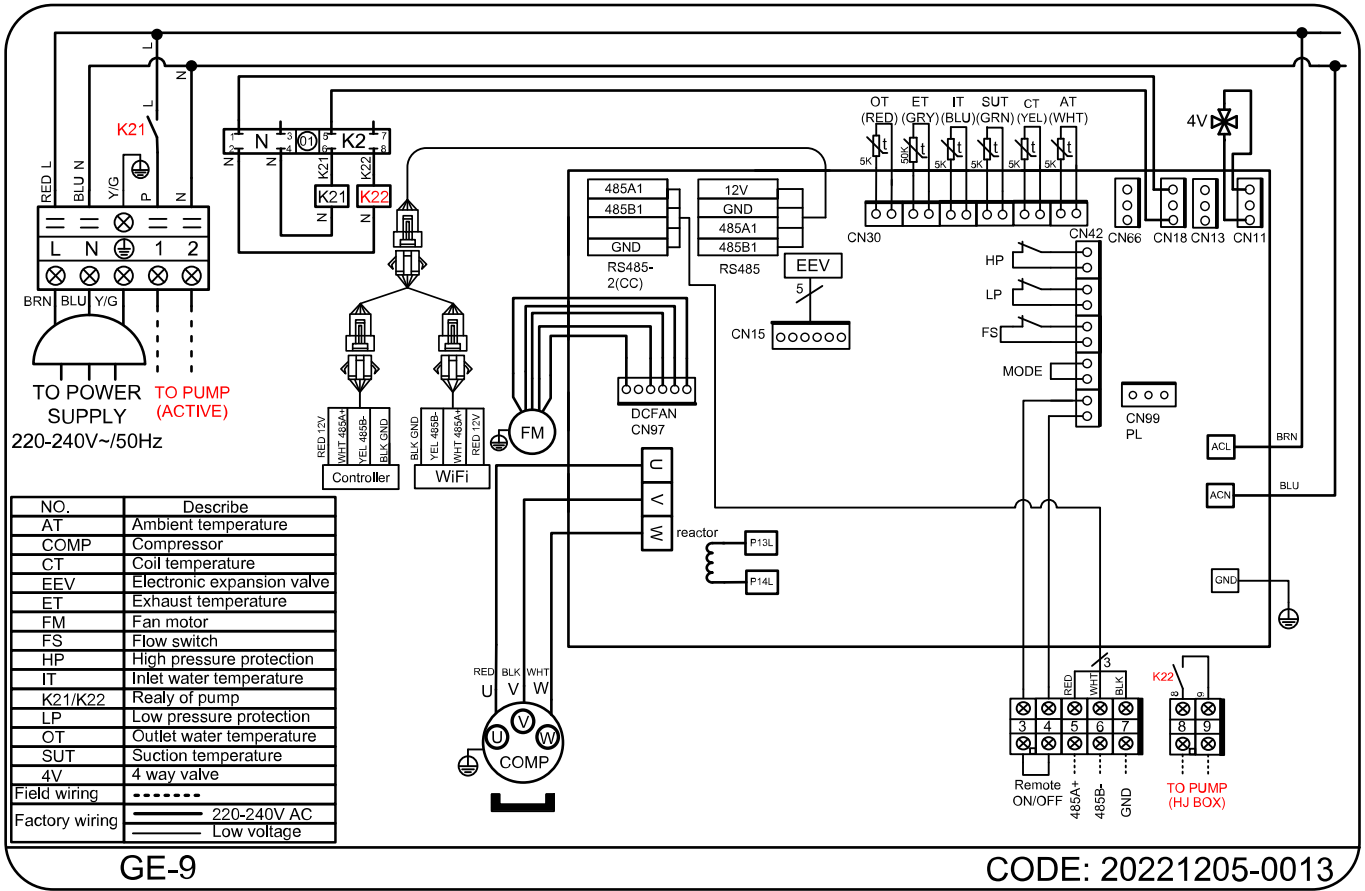

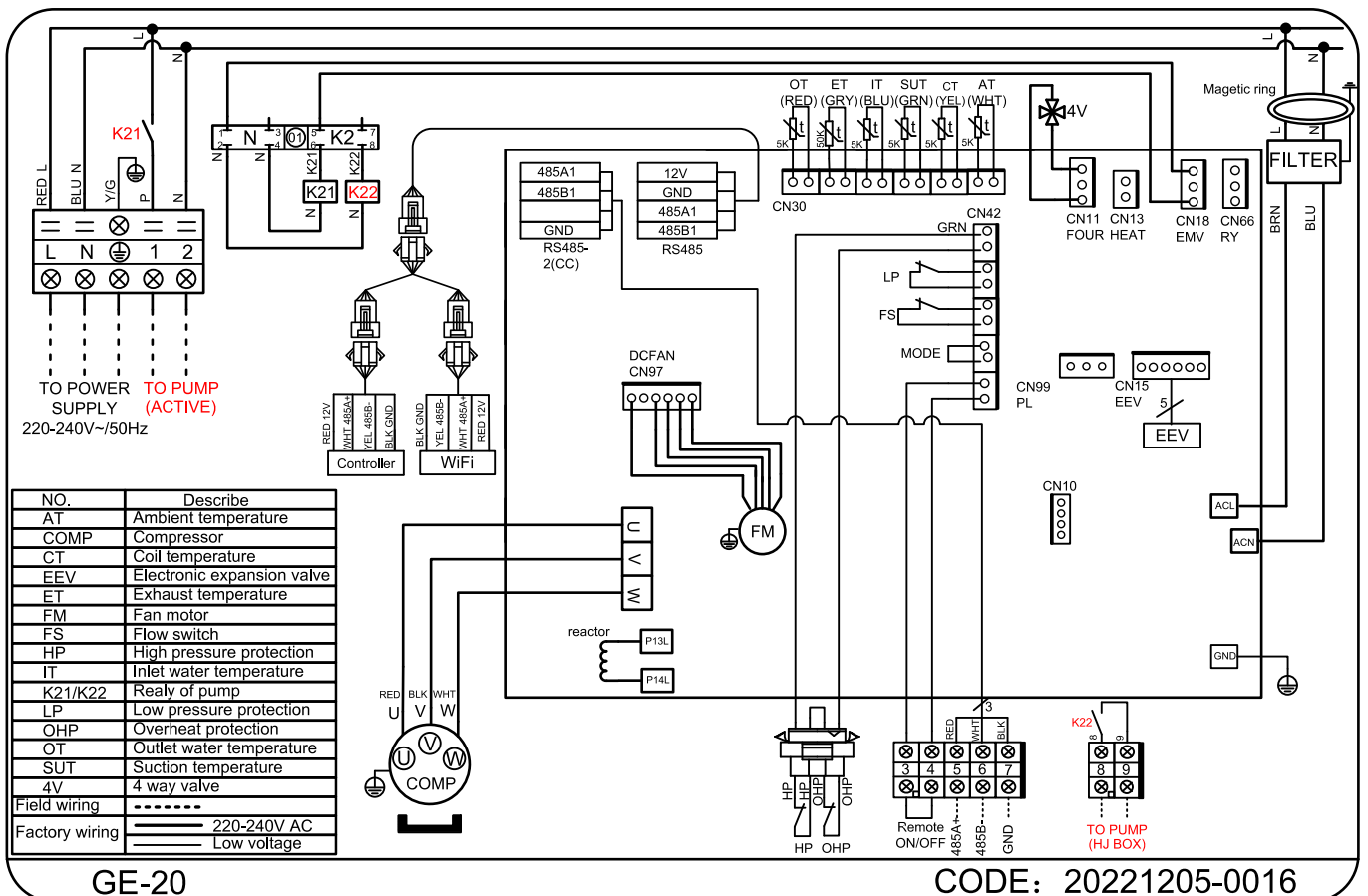
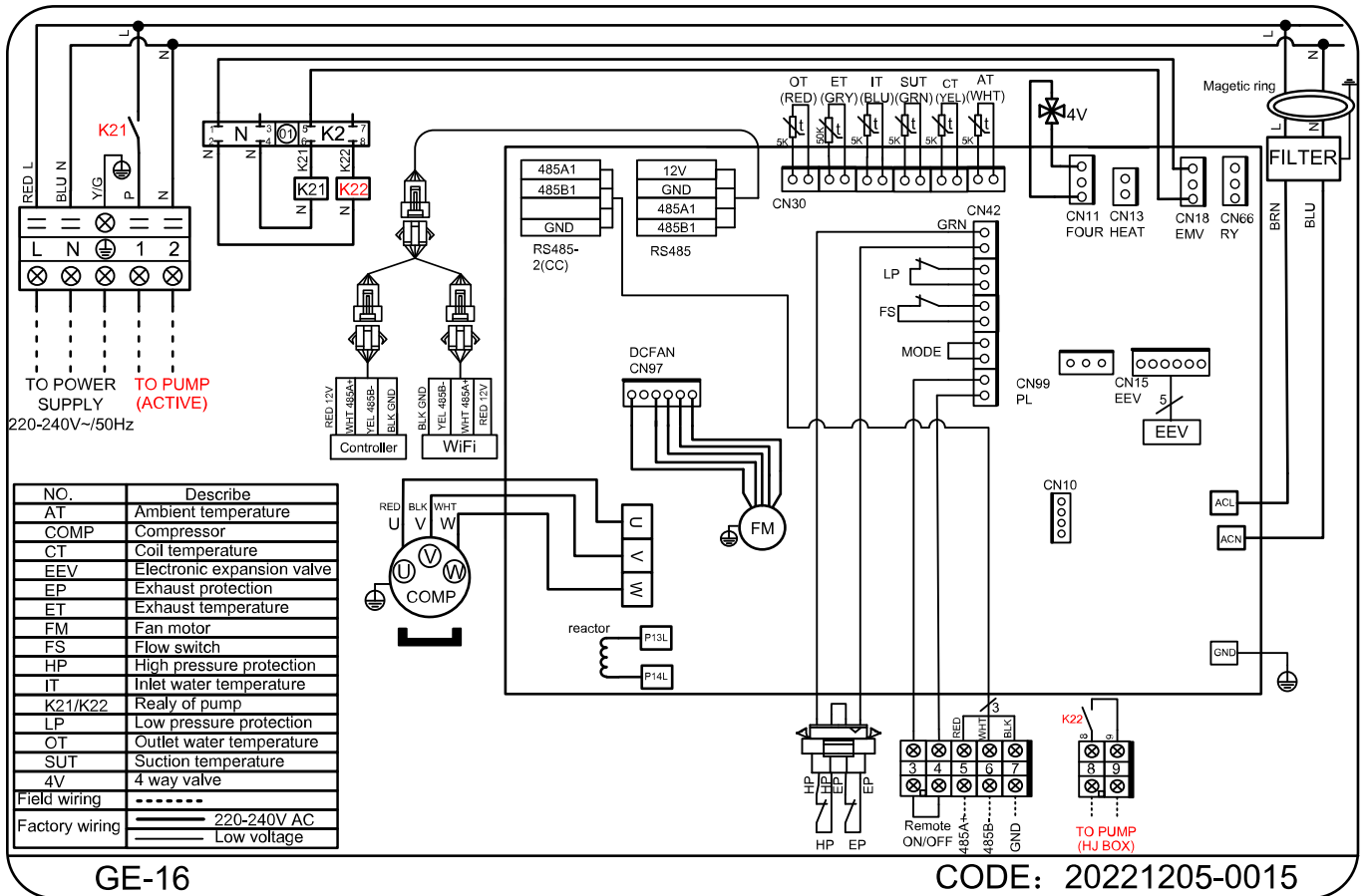

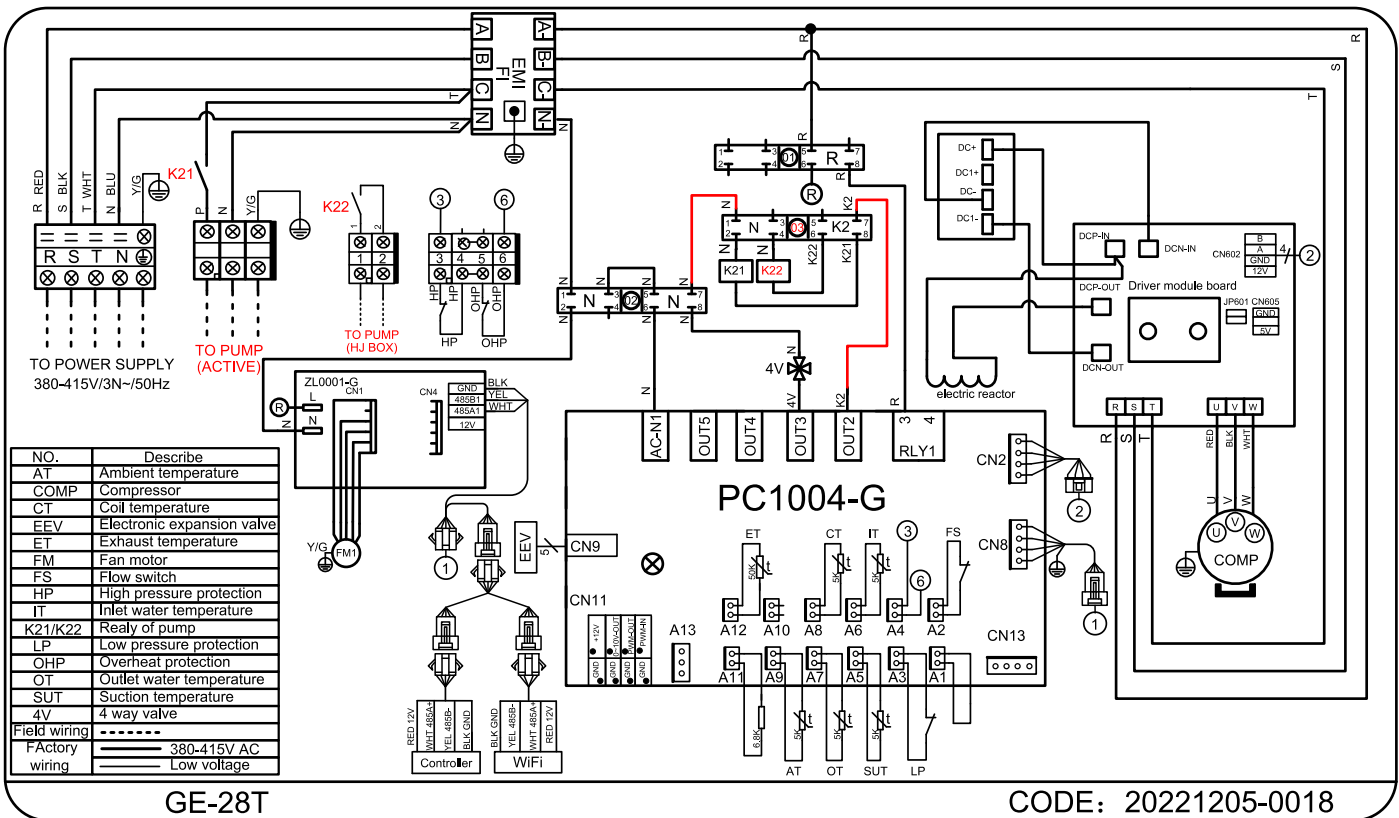
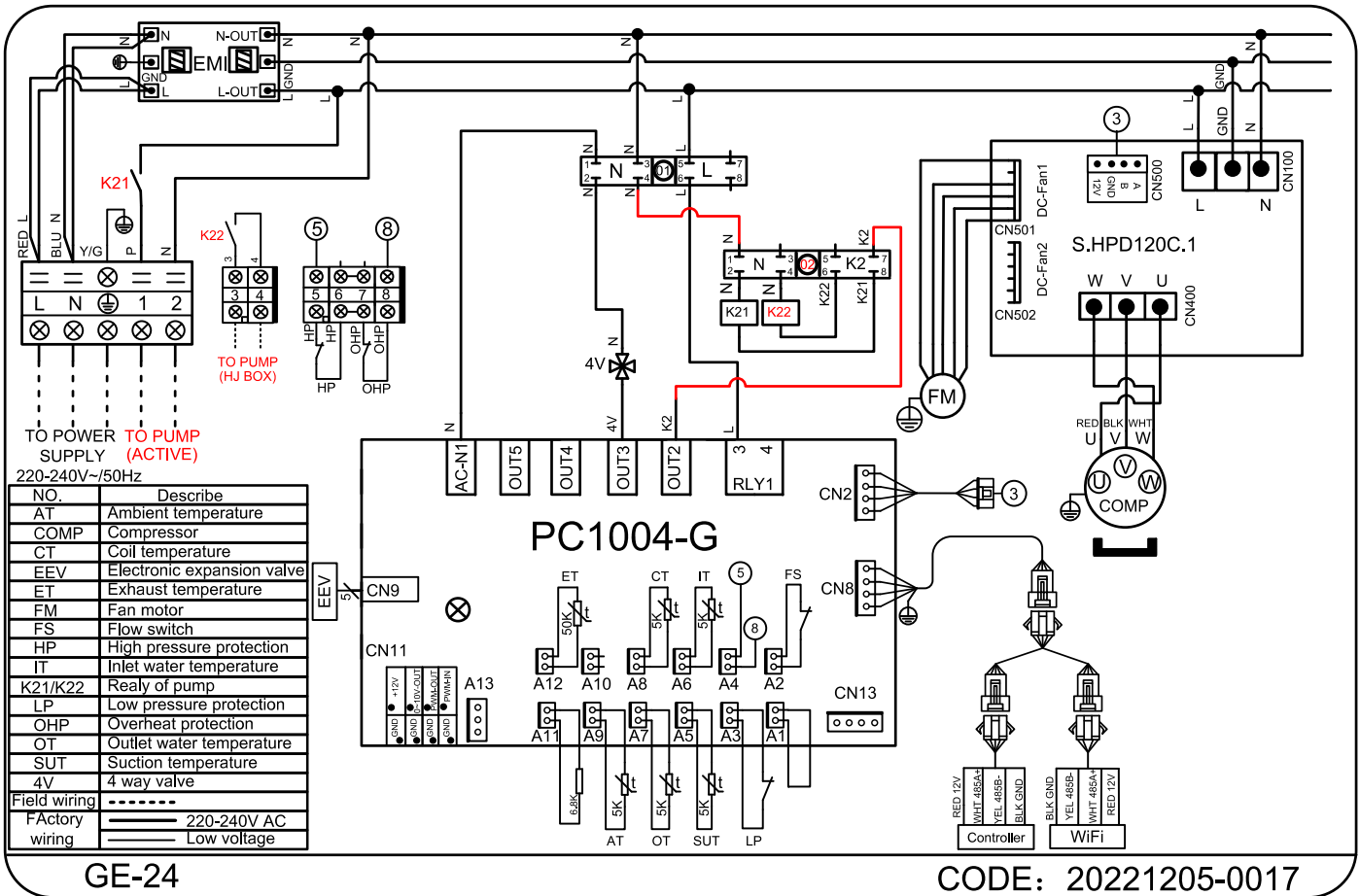

7.5 WARRANTY TERMS

The only warranties given by the company are as set out in this warranty statement. The company gives no other conditions, guarantee, warranty or assurance and in particular, as the buyer is a business consumer who purchases for the purpose of resale, the provisions of the Consumer Guarantees Act 1993 or Australian consumer acts are excluded. The company warranties are offered subject to the goods having been installed and operated in accordance with procedures by the company and those recognized as standard industry practices. This in no way absolves the company from its liability as a manufacturer to the consumer under the Consumer Guarantees Act 1993 and or Australian consumer acts.

25 YEARS	3 YEARS	2 YEARS	1 YEAR
<i>Titanium heat exchanger</i>	<i>Compressor</i>	<i>Parts</i>	<i>Labour</i>

1. Warranty terms are from date of purchase.
2. This warranty excludes any defect or injury caused by or resulting from misuse, abuse, neglect, accidental damage, improper voltage, vermin infestation, incompetent installation, any fault not attributable to faulty manufacture or parts, any modifications which affect the reliability or performance of the unit.
3. This warranty does not cover the following:
 - a. Natural Disasters (hail, lightening, flood, fire etc.)
 - b. Damage by foreign objects
 - c. Rust or damage to paintwork caused by a corrosive atmosphere
 - d. When serviced by an unauthorized person without the permission of Guardian
 - e. When a unit is installed by an unqualified person
 - f. Where a unit is incorrectly installed
 - g. When failure occurs due to improper or faulty installation
 - h. Failure due to improper maintenance (refer Operating Instructions)
 - i. Costs associated with delivery, handling, freighting, or damage to the product in transit.
4. If warranty service is required, you should:
 - a. contact Guardian Support at: support@guardianpoolheating.com.au
 - b. provide as much detail on the issues you are encountering
 - c. provide a copy of your receipt as proof of purchase
 - d. have completed the online *Warranty Registration Form*
5. Onsite technical service is available within a 25km radius of your Guardian Service Agents. Service outside this area will incur a traveling fee.
6. Unless otherwise specified to the purchaser, the benefits conferred by this express warranty and additional to all other conditions, warranties, rights and remedies expressed or implied by the Trade Practices Act 1974 and similar consumer protection provisions contained in legislation of the States and Territories and all other obligations and liabilities on the part of the manufacturer or supplier and nothing contained herein shall restrict or modify such rights, remedies, obligations or liabilities.

LABOUR COSTS

Warranty for installation labour is twelve (12) months from date of purchase.

Any product found to be faulty due to installation/labour fault shall be covered under warranty and will be repaired or replaced by Guardian at their cost for a period of twelve (12) months from date of installation.

All replacement parts / components will be supplied direct by the company. Should the buyer purchase parts / components from their own supplier the company may at their own discretion reject or reimburse the cost to which the company can purchase the part for.